

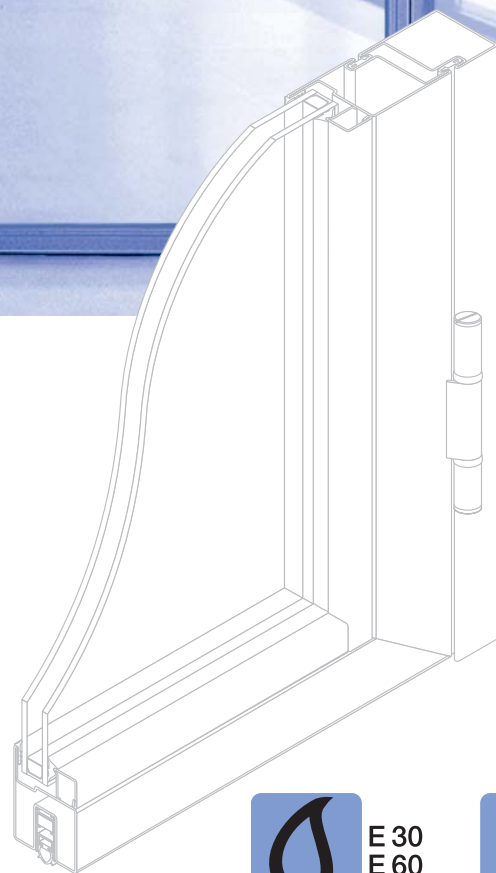

RP-hermetic 50 CS

- Das schlanke Türsystem aus Stahl
- The slim faced door system in steel
- Le système filigrane de porte en acier



E 30
E 60
EW 120



RS

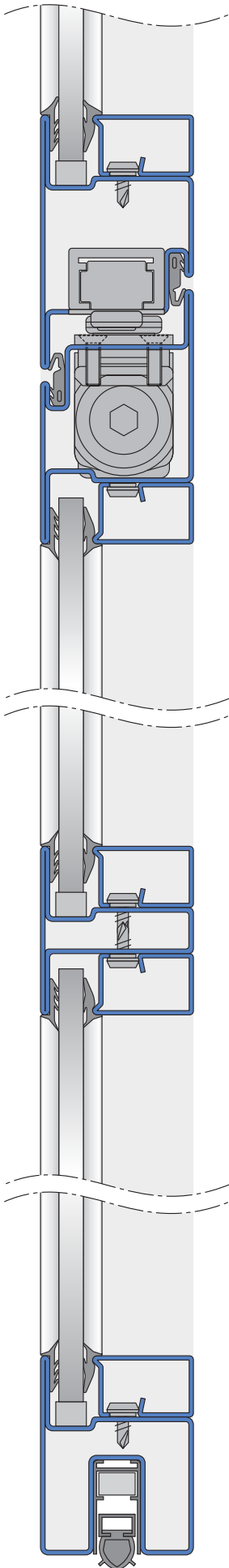

das filigrane System

- die Tür mit den schmalsten Ansichtsbreiten
- auch bei besonders großen Türelementen gleichbleibende Stabilität

der Werkstoff Stahl

- hoch widerstandsfähig
- hoch belastbar
- langlebig und sicher
- stoßfest und stabil
- Garant für dauerhaften Sitz der Bänder
 - kein Absenken
 - kein Nachstellen
- umweltfreundlich

die Architektur

- filigran
- flächenbündig
- ästhetisch

die Verarbeitung

- einfach
- wirtschaftlich

der Rauchschutz

- DIN 18095

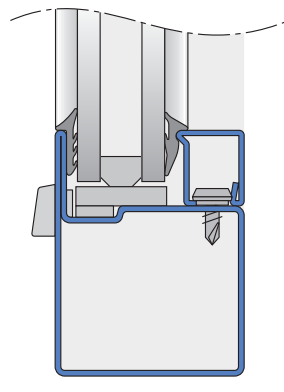

the slim faced system

- extremely slim face width
- extraordinarily strong and stable

steel

- high resistance
- highly durable
- long lasting and secure
- resistant to impact and stable
- everlasting position of the hinges
 - no drop down
 - no adjustment required
- environmentally friendly

architecture

- slimline
- rebated-flush face
- aesthetic

processing

- simple construction
- cost effective

fire and smoke protection

- fire protection BS 476 30,60 and 120 min. integrity
- smoke protection DIN 18095

le système elancé

- la porte avec les vues en face les plus étroites
- stabilité constante, même pour de très grandes portes

l'acier

- haute résistante
- très stable
- longue vie et sécurité
- résistante aux chocs
- assure la bonne fixation des paumelles
 - pas de déformation
 - pas de réglage ultérieur nécessaire
- écologique

l'architecture

- finesse
- surface étroite
- esthétique

l'usage

- simple
- économique

le drainage

- gorge de drainage de la feuillure

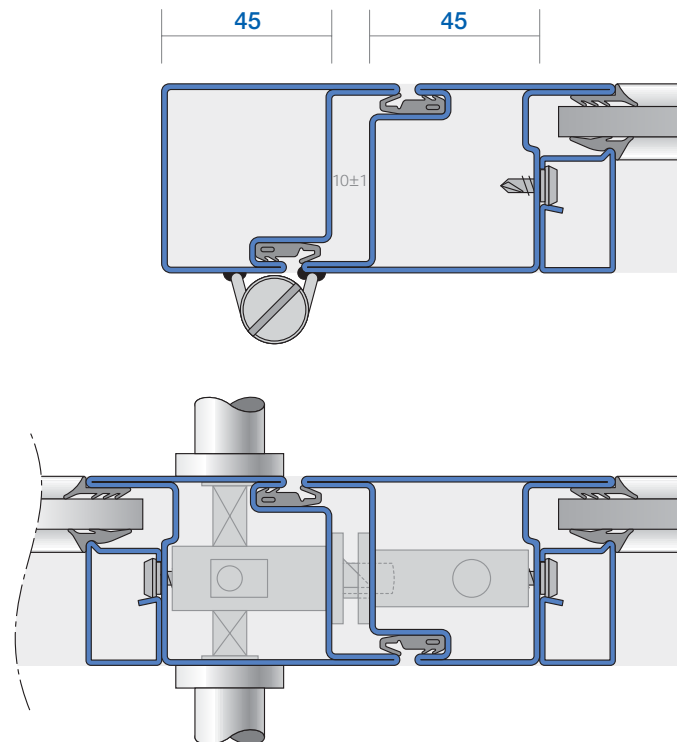

groß – schlank – stark, Kastenmaß nur 45 mm
extremely slim face width, 45 mm wide profile
grand – elancé – fort, chambre de 45 mm

RP-hermetic 50 CS

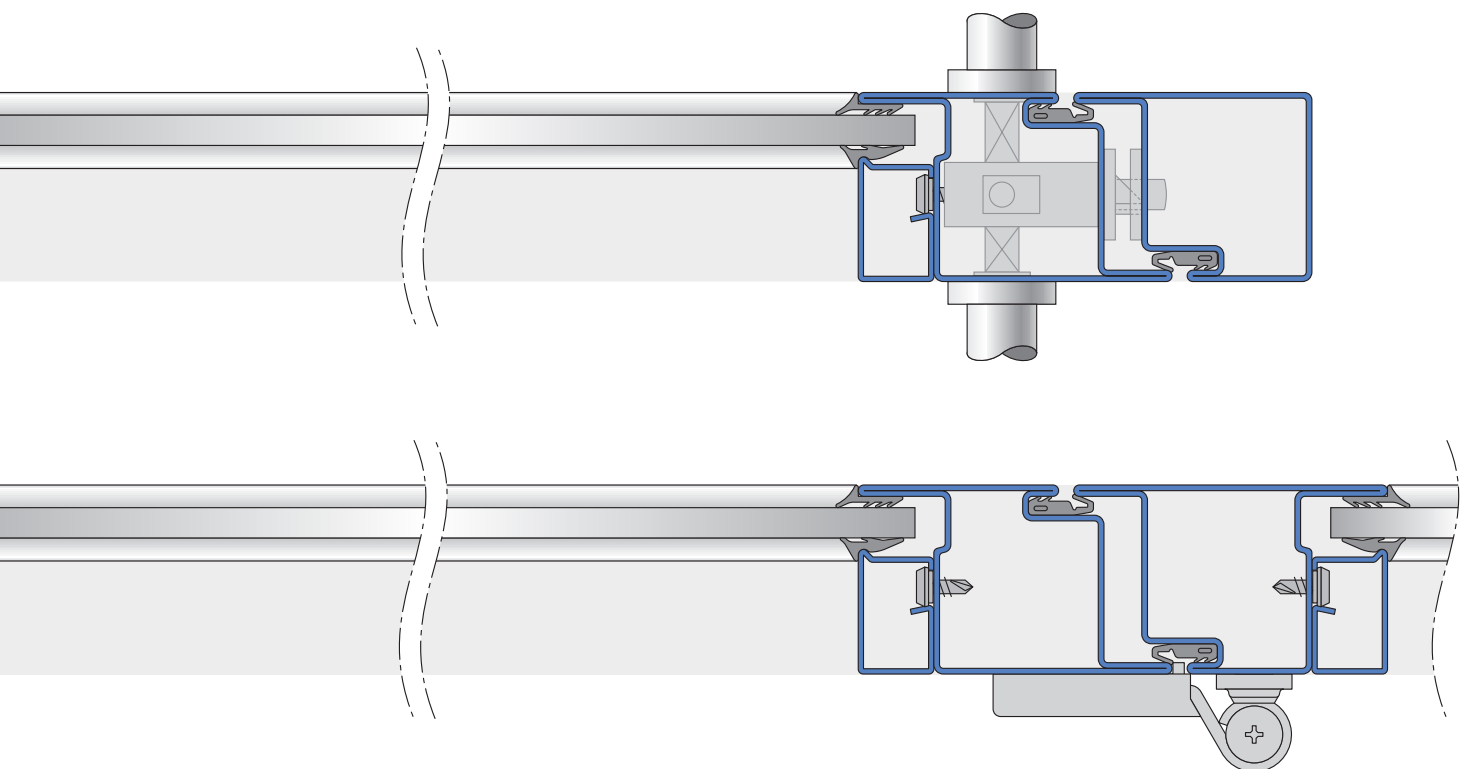
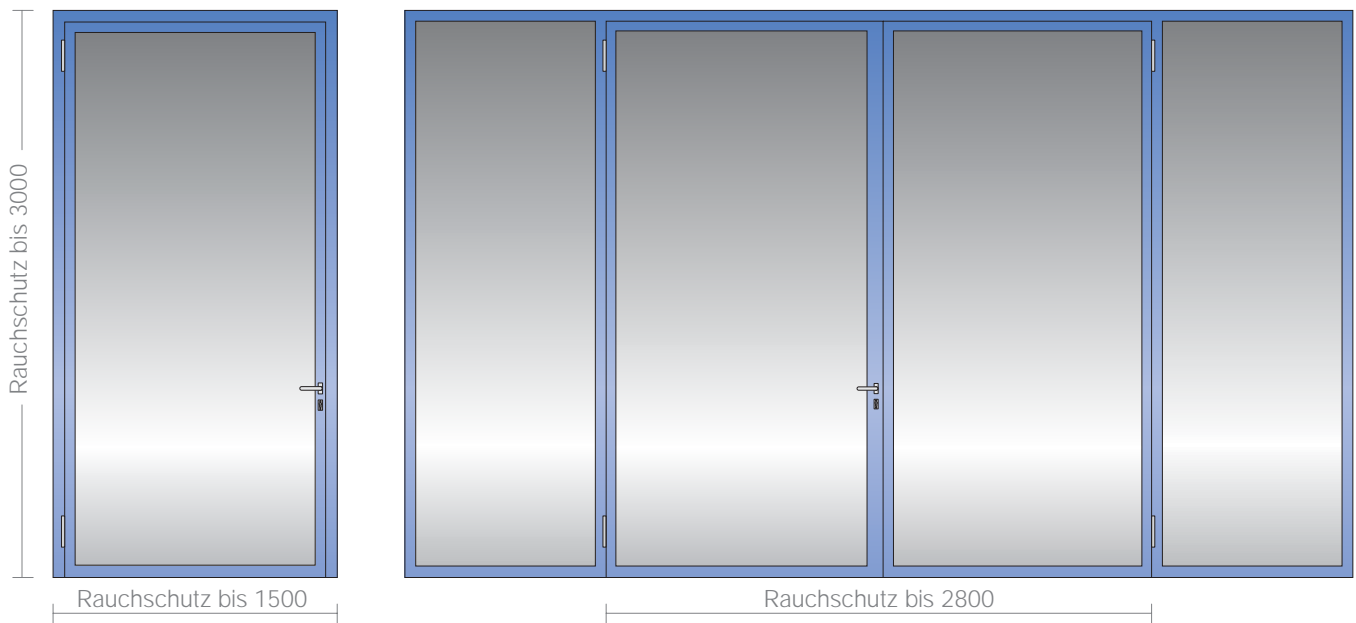

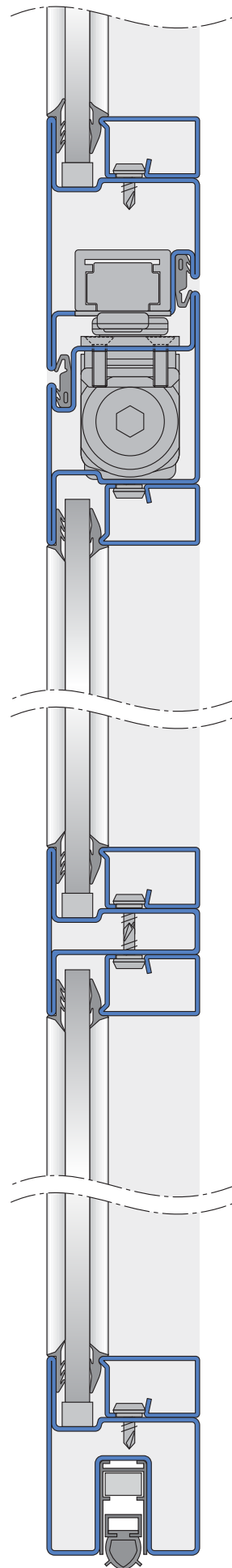

das filigrane System

- die Tür mit den schmalsten Ansichtsbreiten
- auch bei besonders großen Türelementen gleichbleibende Stabilität

der Werkstoff Stahl

- hoch widerstandsfähig
- hoch belastbar
- langlebig und sicher
- stoßfest und stabil
- Garant für dauerhaften Sitz der Bänder
 - kein Absenken
 - kein Nachstellen
- umweltfreundlich

die Architektur

- filigran
- flächenbündig
- ästhetisch

die Verarbeitung

- einfach
- wirtschaftlich

der Rauchschutz

- DIN 18095

the slim faced system

- extremely slim face width
- extraordinarily strong and stable

steel

- high resistance
- highly durable
- long lasting and secure
- resistant to impact and stable
- everlasting position of the hinges
 - no drop down
 - no adjustment required
- environmentally friendly

architecture

- slimline
- rebated-flush face
- aesthetic

processing

- simple construction
- cost effective

fire and smoke protection

- fire protection BS 476 30,60 and 120 min. integrity
- smoke protection DIN 18095

le système elancé

- la porte avec les vues en face les plus étroites
- stabilité constante, même pour de très grandes portes

l'acier

- haute résistante
- très stable
- longue vie et sécurité
- résistante aux chocs
- assure la bonne fixation des paumelles
 - pas de déformation
 - pas de réglage ultérieur nécessaire
- écologique

l'architecture

- finesse
- surface étroite
- esthétique

l'usage

- simple
- économique

le drainage

- gorge de drainage de la feuillure

groß – schlank – stark, Kastenmaß nur 45 mm
extremly slim face width, 45 mm wide profile
grand – elancé – fort, chambre de 45 mm

RP-hermetic 50 CS

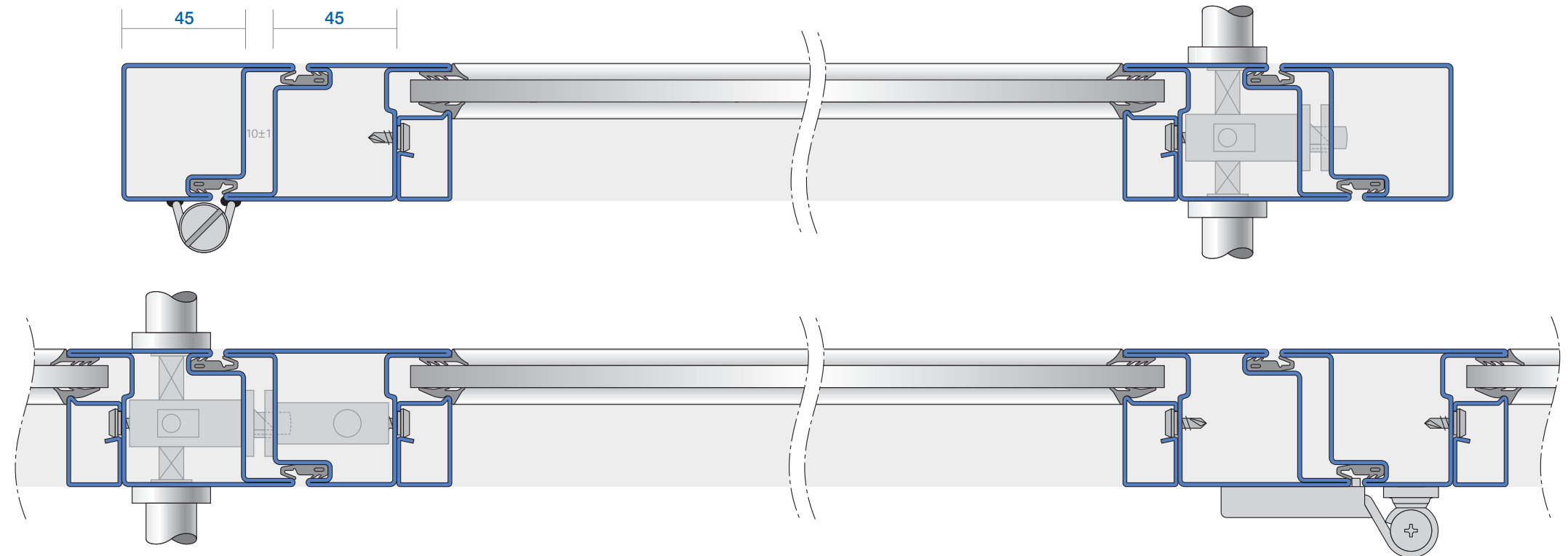
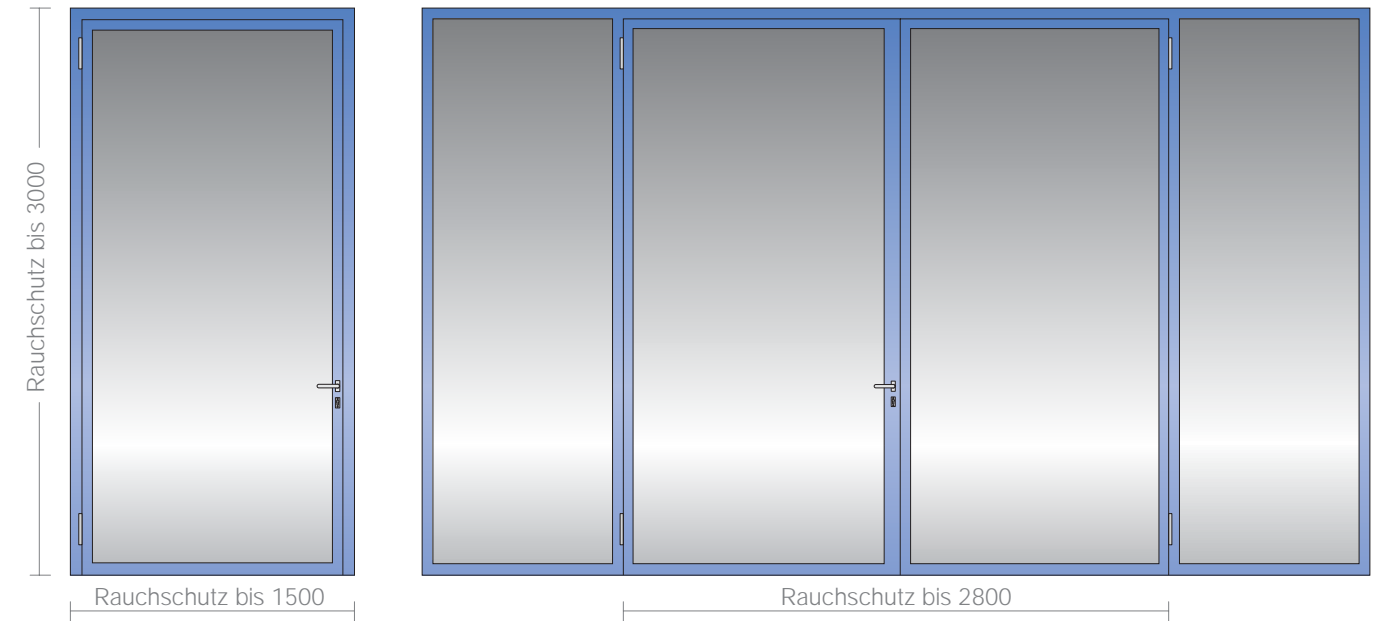

RP-hermetic 50 CS

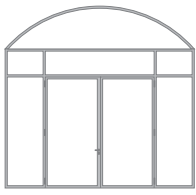



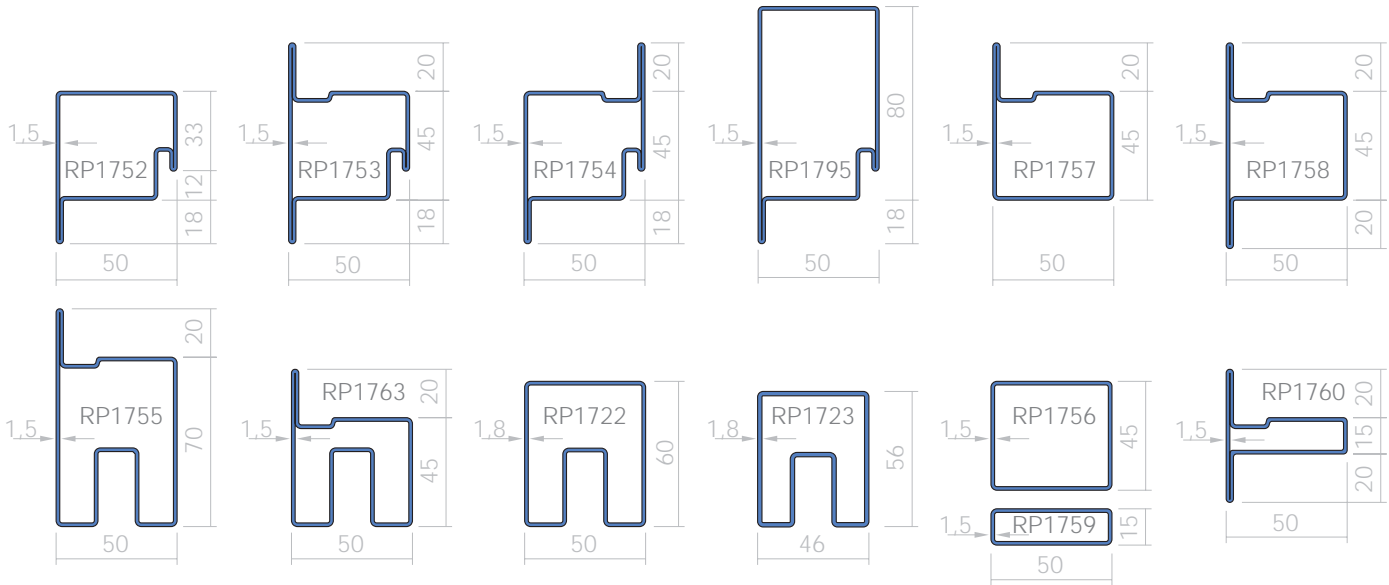



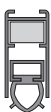

Türprofile
Door profiles
Profils de porte



automatische Bodendichtung / automatic floor seal / joints de seuil automatiques

	Länge / length / longueur	637	762	887	1012	1137	1262	1387 mm	Sondermaße / special sizes / dimensions spéciales
	Gangflügel / primary leaf / vantail de service	200256	200257	200210	200220	200230	200240	200245	200250
	Standflügel / secondary leaf / vantail semi fixe	200306	200307	200260	200270	200280	200290	200295	200300

Verglasungsdichtungen / Glazing seals / joints de vitrage

								
3	3	5	3	4	5	6	7 mm	
300500	300650*	304650*	300510	304140	300520	304160	300570	300550

*selbstklebend / *self adhesive / *auto-adhésif

Anschlagdichtung / rebate door seal / joint de battement

Glashalteleisten, Stahl Glazing beads, steel Parcloses, acier

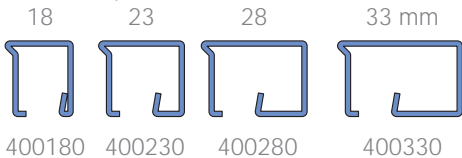

Glashalteleisten, Aluminium Glazing beads, aluminium Parcloses, aluminium

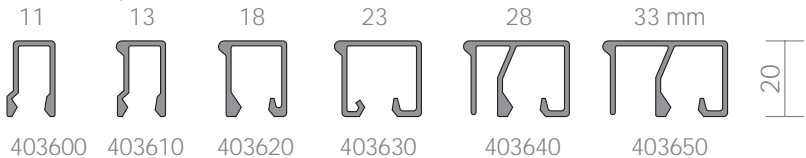

Klemmschrauben / studs / vis de fixation des parcloses



Zusätzliche Informationen siehe Dokumentation, Prüfzeugnisse und Zulassungen!
for further information see manual, test reports and assessments!
pour toute autre information voir documentation, procès-verbaux et rapports d'essai!